

Sommerhuber Lounger Three Plus Height 44cm

Freestanding heated lounger with ergonomically shaped, large-area heat storing ceramics and 2 transverse joints only. Velvety soft ceramic surface with optimal hygiene aspects. This heated Lounger allows for enjoyable indoor use. Thanks to specific characteristics heat storing ceramics emit mild areal infrared warmth, which enhances blood circulation and results in superior relaxation and maintaining of vitality.

Descriptive size: L/W/H ~ 171/69/111 cm

Weight: ~ 99 kg

Article no.: 652 003

Ready to plug-in product.

Available in 18 different glazes.

- EPS sub-construction, colour „offwhite“
- Stability of height 22 and 33 cm with a static load of max. 200 kg, if completely glued to the ground by adhesive and sealed properly. With heights 33 cm or 44 cm, Lounger THREE PLUS is to be fully fixed on the floor by adhesive and sealed properly.
- One-zone electrically heated with an EU 230V heating system (mounted), heat capacity 675W
- Thermostat IP20 for external installation
- Power supply via floor
- Surface temperature:
uncovered up to max. 50°C.
Recommended temperature: ~ 34°C +/- 2°C
- Incl. cable (standard length 2,5m)
- Incl. bolster "Relax", colour „offwhite“
- Optional: LED lights, matching colour to glaze of EPS corpus and headrest, USB connection

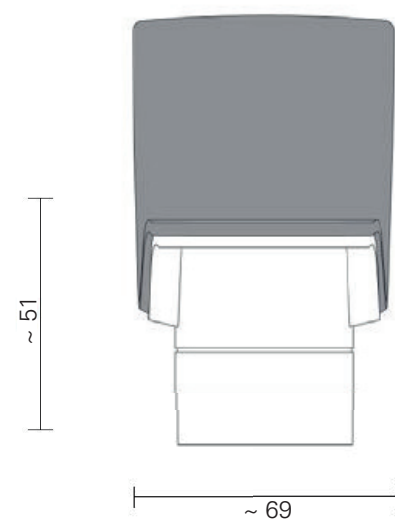
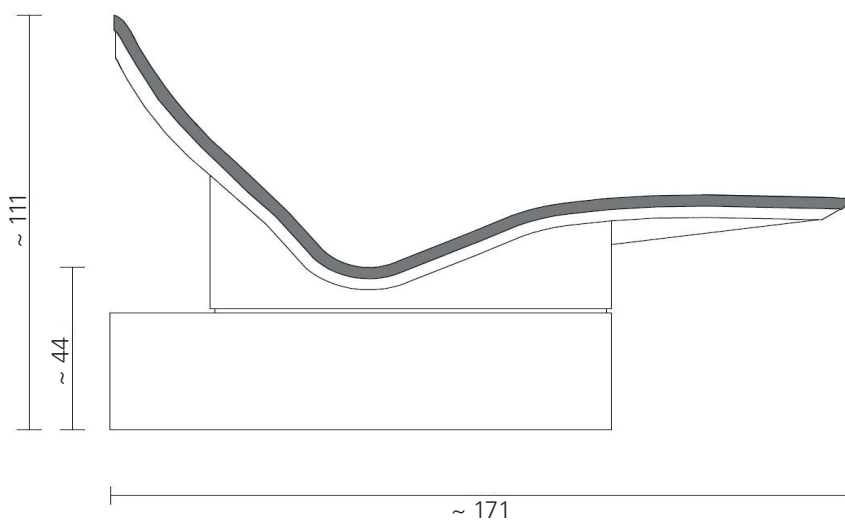

All measurements in cm

This product is maintenance free.

For proper cleaning please use only cleaning agents with PH value between 5.0 - 9.0. Please use soft cleaning clothes only. Abrasive brushes or high-pressure cleaners could damage the glazed surface.